

FIT-UP PRO

By Mathey Dearman

JANUARY 2023

COMPLETE BROCHURE

FIT-UP AND ALIGNMENT TOOLS

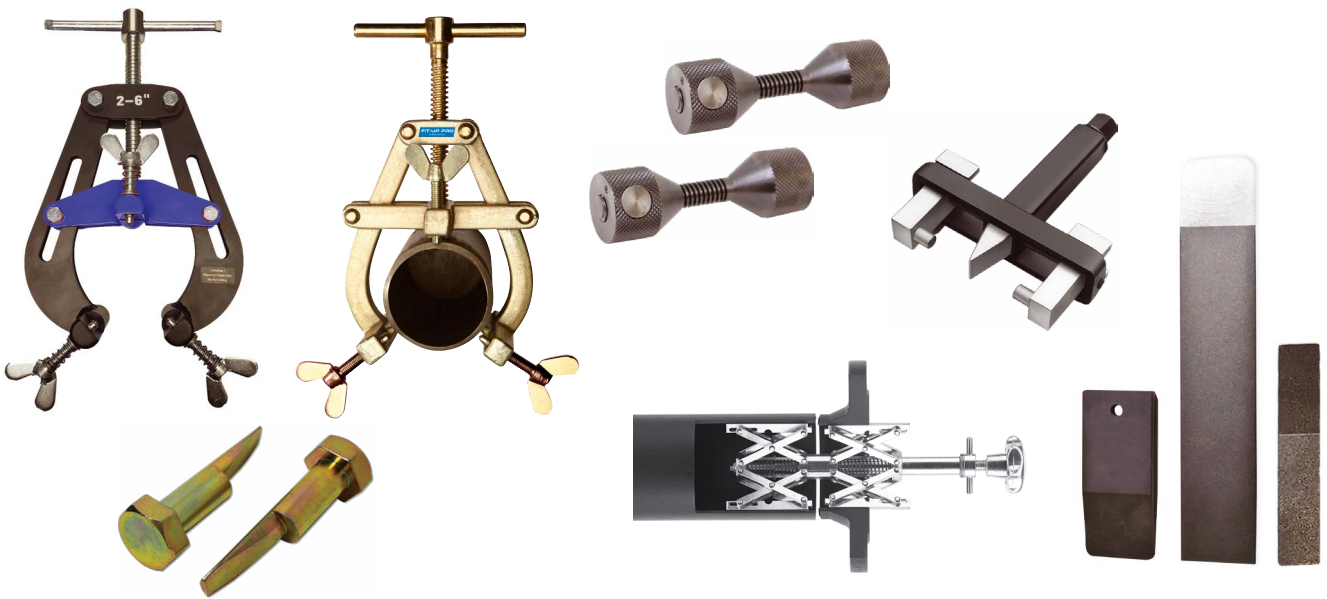

LAYOUT AND MARKING TOOLS





SPECIALIZED FABRICATION EQUIPMENT GROUP

Introduction to S.F.E. Group

S.F.E. Group was founded in 2019 after the merger of three world leading OEM's in the field of pipe fabrication tooling and machinery: B&B Pipe and Industrial Tools LLC (USA), Mathey Dearman Inc. (USA) and TAG Pipe Equipment Specialists (UK). Most recently the S.F.E Group has completed the acquisition of the AXXAIR Group (France).

S.F.E. Group offers a wide range of products and is continuously exploring new product design and development, as well as add-on acquisitions to enhance its portfolio and to fulfil increasing industries' demands.

With offices and warehousing on 4 continents, 120 employees and more than 250 partnerships and distributors worldwide, S.F.E. Group prides itself in consistently offering the highest standard of both product quality and service to all its customers.

S.F.E. Group looks forward to welcoming you into its global network as a partner, distributor or end user customer and remains at your disposal at any time.



UNITED STATES HEAD OFFICE - HOUSTON



INTERNATIONAL HEAD OFFICE - FRANCE

OUR BRANDS

<p>Where There's Pipe, There's Mathey!</p> <ul style="list-style-type: none">PIPE FLAME CUTTING AND BEVELLINGPIPE ALIGNMENT AND REFORMING CLAMPSPIPE RIGGING EQUIPMENT <p>www.MATHEY.COM</p>	<p>The Pipe Fabricators Source</p> <ul style="list-style-type: none">PIPE JACK AND STANDSMEGA ROLLERS AND STANDSMATERIAL HANDLING EQUIPMENT <p>www.BBPIPETOOLS.COM</p>	<p>World Leading Manufacturer of Pipe Beveling and Cutting Machines</p> <ul style="list-style-type: none">PIPE BEVELLING MACHINESPIPE COLD CUTTING MACHINES <p>www.TAG-PIPE.COM</p>	<p>Innovative Orbital Solutions</p> <ul style="list-style-type: none">ORBITAL CUTTING / BEVELLING AND FACINGORBITAL WELDING <p>www.AXXAIR.COM</p>	<p>Purging Solutions for the perfect pipe weld!</p> <ul style="list-style-type: none">PIPE PURGING SYSTEMSPURGE OXYGEN MONITORPIPE S'LOGGERS <p>www.PURGEMASTERS.COM</p>	<p>The Pipe Fitters Companion</p> <ul style="list-style-type: none">FIT-UP AND ALIGNMENT TOOLSLAYOUT AND MARKING TOOLS <p>www.FIT-UP-PRO.COM</p>
--	--	--	--	--	---

FIT-UP PRO

By Mathey Dearman

Introduction to Fit-Up Pro

With the merger in 2019 of B&B Pipe and Industrial Tools LLC (USA), Mathey Dearman Inc. (USA) and TAG Pipe Equipment Specialists (UK) and the recent addition in 2022 of AXXAIR (France) into Specialized Fabrication Equipment (S.F.E.) Group, the various product groups offered by the original manufacturers have been re-aligned and integrated into the overall S.F.E. Group product range whilst keeping their own brand identity.

With having Mathey Dearman supplying pipe fit up tools since the 1930's, S.F.E. Group is proud to present its brand dedicated to one of its most historical product ranges: **Fit-Up Pro by Mathey Dearman**.

With the Fit-Up Pro brand, S.F.E. Group not only wishes to highlight the focus on fit up, alignment and layout tools, but also supply the growing demand and diverse applications on-site in the industries that the S.F.E. Group already serve and intertwine with the other product applications within S.F.E. Group.

As an OEM, S.F.E. Group prides itself being renowned with the Fit-Up Pro brand not only for its history in pipe fitting tools, but also for the continuous innovations and the overall comprehensiveness of this range of fit up, alignment and layout tools, including: external and internal **pipe clamps**, welding **wedges**, **flange spreaders** and **flange aligning tools** and a wide variety of **pipe layout and marking tools**.

Fit-Up Pro's products are available from the international S.F.E. Group branches on 4 continents, as well as from S.F.E. Group's extensive and continuously expanding global network of partners and distributors.

Get in touch for any pipe fitting and pipe aligning application.

FIT-UP AND ALIGNMENT TOOLS



Our spider clamps are great for flange fit up and we also offer other types of alignment pipe clamps that save time and increase productivity. Two hole pins, flange alignment bolts and stepped wedges are also time savers that compliment this line, along with various squares and protractors. We even offer two types of flange spreaders, (manual and hydraulic) that assist in safe maintenance and preparation for re-fit of flanges.

LAYOUT AND MARKING TOOLS



Fit-Up Pro offers several tools specific to pipe layout. A new pocket level and fitters torpedo level are made from aircraft aluminium balancing light weight and durability. A newly designed pipe centering tool adds magnets for hands free use and comes with a right angle square and handy ruler markings, and our line of radius markers is great for laying out a radius or circles up to 100 inches.

TABLE OF CONTENTS

Introduction to S.F.E. Group.....	2
Introduction to Fit-Up Pro by Mathey Dearman.....	3
Fit-Up and Alignment Tools.....	5
Quick-Fit PDQ Pipe Clamps	6
E-Z Fit Gold Pipe Clamps	7
E-Z Fit Spider Internal Clamps	8
Spacing Wedges <i>(Only available in the America's)</i>	9
Flange Spreader <i>(Only available in the America's)</i>	9
Flange Alignment Bolts (FAB Bolts) <i>(Only available in the America's)</i>	10
Push-button Carbon Steel Flange Line Up Pins.....	10
Stainless Steel Flange Pins	11
Rotary Earth Clamp <i>(Not available in the America's)</i>	11
Layout and Marking Tools.....	12
Centering Head	13
Pocket Level	13
Torpedo Level.....	13
Radius Marker	14
Q.C. Welder with Pit Gauge <i>(Only available in the America's)</i>	14
Pipe Wrap.....	14
Pipe Fitter's Square <i>(Only available in the America's)</i>	15
Protractors	15
Framing Square <i>(Only available in the America's)</i>	15
Flange Square <i>(Not available in the America's)</i>	15



SPECIALIZED FABRICATION EQUIPMENT
GROUP

*Our group policy is one of continuous improvements and acquisitions.
Products and data tables are subject to change or vary from those illustrated.*

OUR BRANDS



FIT-UP PRO

By Mathey Dearman

FIT-UP AND ALIGNMENT TOOLS





This classic design high-low alignment clamp has been in used worldwide for years.

With a durable, yet cost effective fabricated design, the PDQ pipe clamps fit up to 14" pipe and are available in three sizes.

Working on stainless steel?

The new Quick-Fit PDQ pipe clamps can be used on stainless steel without any additional accessories due to the stainless steel feet and balls in the wing-nuts, preventing contamination of the pipe.

Specifications

- Available in three sizes for 1" - 14" pipe fit-up.
- Durable ACME-thread design used for years in the field.
- Lightweight design is great for overhead work.
- With stainless steel contact points standard, the PDQ clamp is ready for exotic pipe fabrication out of the box.
- Great for most types of fit-ups. Pipe to pipe, pipe to elbow and pipe to flange amongst others.
- The most cost effective yet durable high-low fit-up clamp on the market.

Technical specification

OLD PART NO	NEW PART NO	DESCRIPTION	RANGE		WEIGHT	
* EZR2	* 1220	Quick-Fit PDQ Pipe Clamp 1" - 3"	1" - 3"	25 - 90 mm	4 lbs.	1.80 kg
* EZR6	* 1221	Quick-Fit PDQ Pipe Clamp 2" - 6"	2" - 6"	50 - 170 mm	11 lbs.	5.00 kg
* EZR12	* 1222	Quick-Fit PDQ Pipe Clamp 6" - 14"	6" - 14"	165 - 370 mm	18 lbs.	8.20 kg

* Suitable for stainless steel

Quick Fit PDQ Typical Applications



WARNING: These PDQ clamps must not be used as a lifting device, as this may result in damage or injury

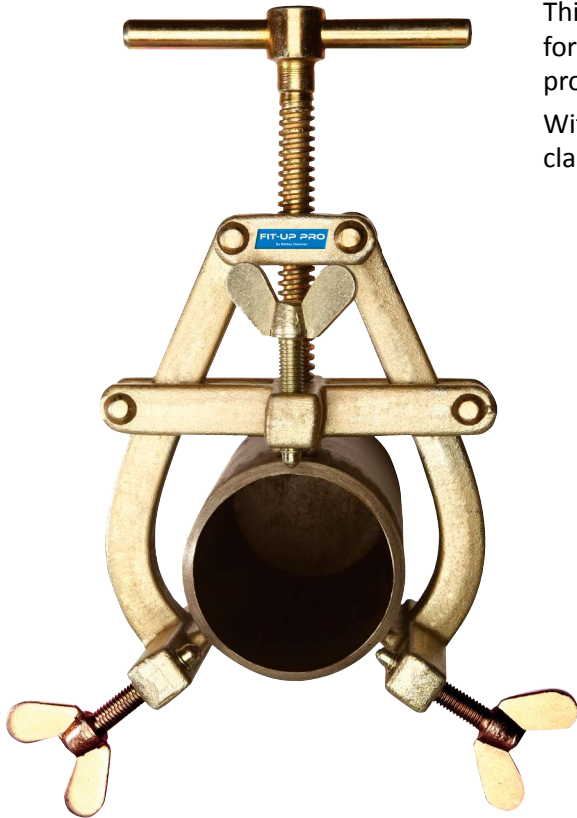

This classic design high-low alignment clamp has been in used worldwide for years. The heavy-duty design utilises forged steel, galvanised to offer protection to ensure a robust product.

With a durable, yet cost effective fabricated design, the E-Z Fit Gold pipe clamps fit up to 14" pipe and are available in five overlapping sizes.

Specifications

- Available in five sizes for 1" - 14" pipe fit-up.
- Heavy-duty design: forged steel, galvanised.
- Great for most types of fit-ups. Pipe to pipe, pipe to elbow and pipe to flange amongst others.
- The most heavy-duty high-low fit-up clamp on the market.

Optional extras

Stainless steel covers can be fitted quickly to the clamping feet. This makes all contact points of the clamp stainless, thus eliminating contamination of the pipe.



Sizes available

PART NO.	DESCRIPTION	RANGE		WEIGHT	
EZG3	E-Z Fit Gold Pipe Clamp 1" - 3"	1" - 3"	20 - 90 mm	3 lbs.	1.40 kg
EZG5	E-Z Fit Gold Pipe Clamp 2" - 5"	2" - 5"	50 - 150 mm	7 lbs.	3.00 kg
EZG7	E-Z Fit Gold Pipe Clamp 3" - 7"	3" - 7"	90 - 195 mm	7.5 lbs.	3.30 kg
EZG9	E-Z Fit Gold Pipe Clamp 5" - 9"	5" - 9"	125 - 245 mm	15.5 lbs.	7.00 kg
EZG14	E-Z Fit Gold Pipe Clamp 9" - 14"	9" - 14"	225 - 370 mm	20 lbs.	9.00 kg

Stainless steel covers and screws only

PART NO.	PIPE CLAMP SIZE (INCH)
* EZG3SS	1 - 3"
* EZG5SS	2 - 5"
* EZG7SS	3 - 7"
* EZG9SS	5 - 9"
* EZG14SS	9 - 14"

** Suitable for stainless steel*

E-Z Fit Gold Typical Applications

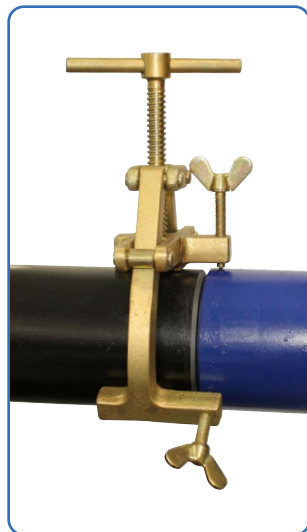
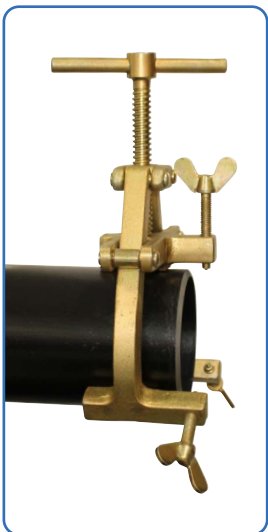

WARNING: These E-Z Gold pipe clamps must not be used as a lifting device, as this may result in damage or injury

SPIDER CLAMP - SERIES 400

This model has two independent expanding clamps, allowing independent alignment of two hollow cylindrical components of different diameters. The bottom expanding clamp is inserted and clamped in the pipe by means of the knob. Then the other part (e.g. a flange) is placed over the top expanding clamp and clamped by means of the hand-bar. This model is specially suited for heavy parts. All locating rails are in stainless steel.

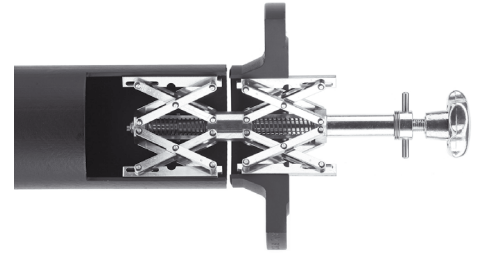

PART NO	CLAMPING RANGE		WEIGHT	
* 400-1 SS	2" - 6"	54 - 140 mm	3.31 lbs.	1.50 kg
* 400-2 SS	4" - 8"	85 - 220 mm	9.15 lbs.	4.15 kg
* 400-3 SS	6" - 14"	120 - 350 mm	26.01 lbs.	11.80 kg
* 400-4 SS	8" - 20"	180 - 520 mm	65 lbs.	30.00 kg
* 400-5 SS	16" - 36"	400 - 940 mm	145 lbs.	65.00 kg

** Suitable for stainless steel*

ELBOW SPIDER CLAMP - SERIES 500

This model with two independent clamps is used for clamping flanges of all kinds and similar parts to elbows and pipe-bends of various diameters. The lower expanding clamp has strong gripping feet which insert into the bend and are tightened by means of the knob. The top expanding clamp is tightened by means of the handbar in the flange.

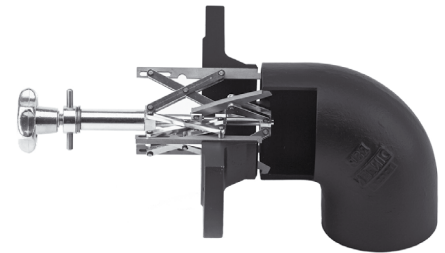

PART NO	CLAMPING RANGE		WEIGHT	
* 500-1 SS	2" - 4"	54 - 115 mm	2.53 lbs.	1.15 kg
* 500-2 SS	4" - 7"	85 - 195 mm	7.05 lbs.	3.20 kg
* 500-3 SS	6" - 12"	120 - 315 mm	21.16 lbs.	9.60 kg
* 500-4 SS	7" - 20"	180 - 520 mm	55 lbs.	25.00 kg

** Suitable for stainless steel*

SCISSOR CLAMP - SERIES 100

For quick and accurate alignment of pipes of equal or differing diameters on a common centre line. Automatic diameter compensation. There's no need to make additional adjustments. All parts stay easily accessible for welding.

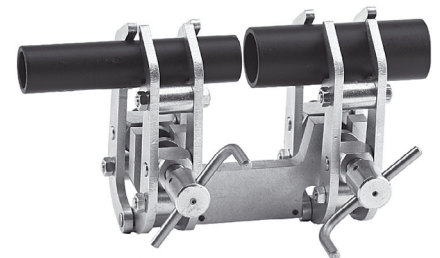

PART NO	CLAMPING RANGE		WEIGHT	
* 100-1 SS	1/8" - 3"	10 - 70 mm	4.85 lbs.	2.20 kg
* 100-2 SS	1.5" - 5"	40 - 140 mm	11.90 lbs.	5.40 kg
* 100-3 SS	2.5" - 12"	75 - 330 mm	55 lbs.	25.00 kg

** Suitable for stainless steel*



When using Mathey Dearman clamps, spacing wedges enable better fit-up of pipe ends. Wedges are used to create precise weld gaps.

Simply move the pipe ends together, mount and tighten the chain clamp or cage clamp and spread the gap to the desired width using the spacing wedge.

The wedge portion of the spacing wedge is case hardened for long life, while the upper part of the wedge is soft enough to prevent splintering.



Purchase individually, or in boxes of 10 each.

Clip to belt or hang in tool box.



Weld gap can be quickly set using our spacing wedges.

PART NO	DESCRIPTION	DIMENSIONS
D274	D274 spacing wedge	4" x ¾" x ¼"
D272	D272 spacing wedge	3½" x 1½" x ¼"
D271	D271 spacing wedge	8" x 1½" x ¼"
BOXES OF 10		
D274-BOX	D274 spacing wedge - box of 10	
D272-BOX	D272 spacing wedge - box of 10	
D271-BOX	D271 spacing wedge - box of 10	



Flange spreaders separate flanges safely and easily without hammering. The spreader, which attaches to the flange holes, spreads the flange faces without damaging flange sealing surfaces. The wedge action of the spreader widens the gap between flanges up to 1¼" (32 mm). 100 ft-lbs. of torque applied to the flange spreader yields up to 12,000 lbs. of spreading force.

Hydraulic flange spreaders are available for 2" - 36" (51 - 914 mm) flanges and use a hydraulic pump kit (sold separately) to easily separate flanges.



PART NO. D100



PART NO. D103



PART NO. D104-KIT



APPLICATION PHOTO

PART NO	DESCRIPTION	FLANGE SIZE	FLANGE RATING	
D100	Mechanical flange spreader 2" - 12"	2" - 12"	51 - 305 mm	up to 300 psi
D103	Hydraulic flange spreader 2" - 12"	2" - 12"	51 - 305 mm	up to 300 psi
D101	Hydraulic flange spreader 12" - 24"	12" - 24"	305 - 610 mm	150 - 600 psi
D102	Hydraulic flange spreader 26" - 36"	26" - 36"	660 - 914 mm	150 - 600 psi
D104-KIT	Hydraulic pump kit includes pump with reservoir, hoses and quick disconnects.			

FLANGE ALIGNMENT BOLTS (FAB BOLTS)



Safe, fast, and effective solution for even the toughest flange alignment jobs. The tool's tapered shaft eliminates hammering and prying when lining up flange bolt holes.

Safer: Eliminates the need for wedges or hammers.

Protects: Greatly reduces risk of damage to the flange.



NEW

Step 1: Place first bolt into pair of aligned holes

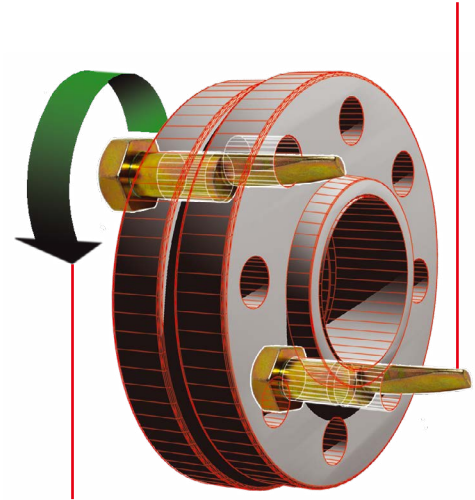

Step 2: Place second bolt into mis-aligned holes and turn bolt to align both flange faces

PART NO	DESCRIPTION
FAB.138	1 3/8" Flange Alignment Bolts (FAB) (pair)
FAB.114	1 1/4" Flange Alignment Bolts (FAB) (pair)
FAB.118	1 1/8" Flange Alignment Bolts (FAB) (pair)
FAB.100	1" Flange Alignment Bolts (FAB) (pair)
FAB.078	7/8" Flange Alignment Bolts (FAB) (pair)
FAB.034	3/4" Flange Alignment Bolts (FAB) (pair)
FAB.BOX	Tool box only
FAB.KIT	FAB kit containing 1 set of: 3/4", 7/8", 1", 1 1/8", 1 1/4" and 1 3/8"

PUSH-BUTTON CARBON STEEL FLANGE LINE UP PINS

Introducing the latest addition to our Flange Line Up Pins (FLUP) range, our new push-button carbon steel model. The new flange line up pin installs and removes quickly thanks to its convenient push-button operation. Rugged ACME-thread and rust-resistant black oxide coated carbon steel means you can expect years of reliable use.



Push-button FLUP

PART NO	DESCRIPTION	FLANGE HOLE DIAMETER RANGE	
05.0100.020	Push-button carbon steel FLUP (pair)	5/8" - 1 1/8"	16 - 47 mm

Features

Fit-Up Pro stainless steel flange pin, aka “two hole pins” are used for precise flange leveling and alignment. The PN 2124 are smaller stainless steel mini pins that fit flange holes up to 7/8". The knurled surfaces are an additional feature that allow snug flange hole fitting that increases accuracy during flange alignment.

Specifications

- Fit-Up Pro flange pins are an economical and efficient way to align flanges.
- PN 2124 for use in 1/4" - 7/8" holes.
- PN 2124 are made of stainless steel for exotic flange fit-ups.
- The flange pins offer knurled handles for increase grip and tightening ability.
- Items come in retail packaging.

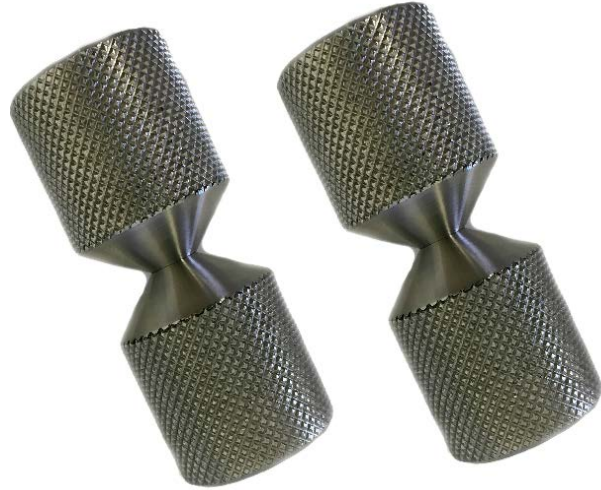

PN 2124

1/4" - 7/8" Flange holes

PART NO	DESCRIPTION	FLANGE HOLE DIAMETER RANGE	
2124	Stainless steel flange pins (pair)	1/4" - 7/8"	6.5 - 22 mm



Features and advantages

- Attaches and detaches in seconds
- Makes up earth leads three ways - lug, clamp on and bare cable
- No more tangled earth leads



A simple yet effective device eliminates earth lead twisting, tangling and unnecessary wear.

Provides a stable earth for circumferential welding of pipes and fittings and eliminates weld pinholes caused by poor earthing.

Anti-arc bearings take loads of up to 400 amps.

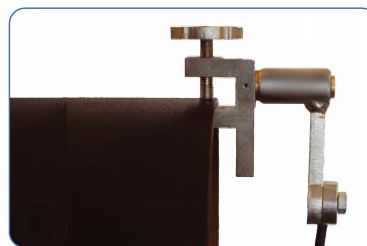

PART NO.	DESCRIPTION	WEIGHT	
REC1	Rotary Earth Clamp	4.0 lbs.	1.80 kg

FIT-UP PRO

By Mathey Dearman

LAYOUT AND MARKING TOOLS

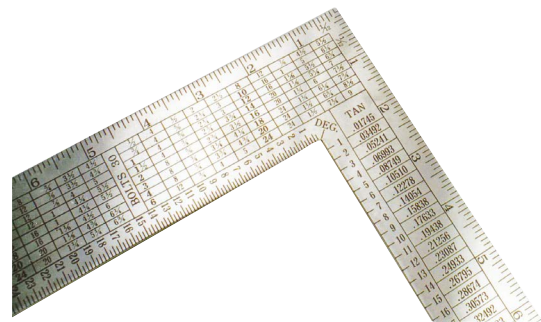

The Fit-Up Pro D206 centering head is a precision tool, useful for finding pipe centerlines, establishing angles or points around pipes, shafts, tanks or other cylindrical surfaces. The rotating protractor dial is marked in 2.5° increments for precise point location. The centering head is designed for use on cylindrical surfaces from 3" to 40" in diameter.



Features

- **True** - Precisely locates top dead center
- **Easy** - Simple and quick to use
- **Versatile** - Use to find points on shafts, tanks, or pipe

PART NO	DESCRIPTION	SHIPPING WEIGHT		SHIPPING DIMENSIONS	
D206	Magnetized pipe centering finder w/punch and multi-tool	3 lbs.	1.35 kg	8" x 8"	200 x 200 mm

The robust aluminium construction, rotating dial and magnetized base makes this tool a handy must-have for all tradesmen.



Features

- 2" x 2" - small and convenient
- Rotating dial allows for easy angle verification
- Magnetized for hands-free use
- Sturdy and durable for years of use

PART NO	DESCRIPTION	SHIPPING WEIGHT		SHIPPING DIMENSIONS	
D208	Magnetized pocket level and inclinometer (2 x 2.5 inch)	1 lbs.	0.45 kg	4" x 4"	100 x 100 mm

The Fit-Up Pro torpedo level is a must have for the pipe fabricator offering multiple features. Magnets adhere the level to the pipe, while a rotating degree dial makes angle verification easy. Two fixed dials make common fit ups easy.

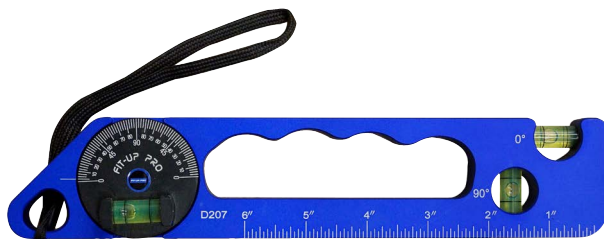

Features

- Easy to read dial and fixed vials
- V-grooved and magnetized base for hands free use
- Laser etched measurements makes this a two-in-one tool

PART NO	DESCRIPTION	SHIPPING WEIGHT		SHIPPING DIMENSIONS	
D207	Magnetized torpedo level	2 lbs.	0.90 kg	12" x 4"	300 x 100 mm

RADIUS MARKER

Robust construction and tensioned, yet easy to move, joints make this the perfect precision tool for all welders and fitters. Lay out saddle cuts, circles, half round, oval or elliptical cuts with confidence.



Features

- Full aluminium construction
- 3 sizes up to 100"
- Can hold rectangular or round soap stone

PART NO	DESCRIPTION	SHIPPING WEIGHT		SHIPPING DIMENSIONS	
D209	Small - radius marker up to 22" circle	1 lbs.	0.50 kg	6" x 2" x 1"	150 x 50 x 25 mm
D210	Medium - radius marker up to 50" circle	1 lbs.	0.50 kg	10" x 2" x 1"	250 x 50 x 25 mm
D211	Large - radius marker up to 100" circle	1 lbs.	0.50 kg	14" x 2" x 1"	400 x 50 x 25 mm

Q.C. WELDER WITH PIT DEPTH GAUGE

The Q.C. welder with pit depth gauge measures pit depth, weld height and outside "high-low". The stainless steel pit depth gauge mounts on the end of the Q.C. welder's gauge housing and displays in English measurements.

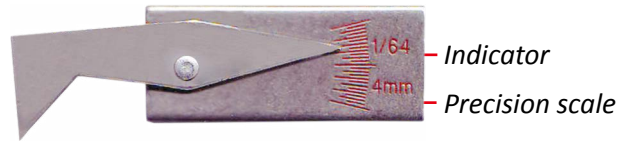

Precise: Measures as small as 1/64" (0.4 mm)

Easy: Simply slide the pit depth gauge over the Q.C. gauge and take the reading

Measurement 1/64th or .4 mm increments.

PART NO	DESCRIPTION	WEIGHT	
D253E	English Q.C. welder with pit depth gauge	0.2 lbs.	0.10 kg
D253E-BOX	English Q.C. welder with pit depth gauge (box of 10)	2.0 lbs.	0.90 kg

PIPE WRAP

Fit-Up Pro by Mathey Dearman pipe wrap has double-ruled edges so it is never upside down or backwards. The wrap can be used as a straight edge to mark straight lines around the pipe and to mark angles for pipe elbows. The pipe wrap is constructed of highly abrasion and solvent resistant materials to last under heavy use.

Pipe wrap includes: table of tangents and straight edge, instructions for cutting elbows, sides marked in 1/8" (3.2 mm) increments to 36" (914 mm), instructions for finding the length of an elbow, 45 degree angle chart and degree markings.



PART NO	DESCRIPTION	PIPE SIZE	
D160	Wrap, 4" x 4 ft / 102 mm x 1,219 mm	3" - 15"	76 - 381 mm
D170	Wrap, 4" x 6 ft / 102 mm x 1,829 mm	3" - 22"	76 - 559 mm
D177	Wrap, 4" x 7 ft / 102 mm x 2,134 mm	3" - 26"	76 - 660 mm
D184	4" / 102 mm width x length desired sold in 1 ft / 305 mm increments*	Pipe size to be specified	
D185	5" / 127 mm width x length desired sold in 1 ft / 305 mm increments*	Pipe size to be specified	
D187	7" / 178 mm width x length desired sold in 1 ft / 305 mm increments*	Pipe size to be specified	



PIPE FITTER'S SQUARE

The stainless steel pipe fitter's square is the only precision square designed specifically for pipefitters, boilermakers, welders and layout persons.

After becoming familiar with the scales and tables of the square, many complex problems encountered during pipe fit-up and layout work are easily solved.

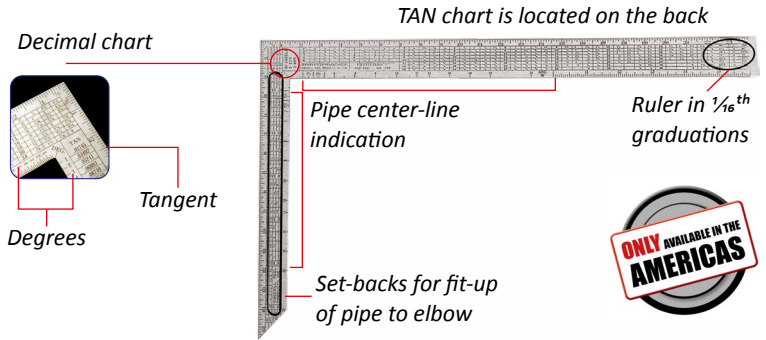

PART NO	DESCRIPTION	DIMENSIONS	
D248	Pipefitter's square	15½" x 24" x ⅜" thick	394 x 610 x 3 mm thick

PROTRACTORS

The large protractor will measure squareness of pipe ends up to 40" / 1,016 mm diameter or can be used to check large pipe miter angles up to 180°. Leg lengths of 48" / 1,219 mm and 36" / 914 mm.

The small protractor is an excellent tool for sheet metal layout, checking squareness of pipe ends up to 17" / 432 mm diameter. It has a large 18" / 457 mm leg, a shorter 12" / 305 mm leg and it is accurate to ± 1°.

The mini protractor can be used for a variety of applications including measuring bevel angle.



PART NO DK-239

PART NO	DESCRIPTION	DIMENSIONS	
DXX-250	Mini stainless steel protractor	4"	102.4 mm
DK-239	Small stainless steel protractor	18" & 12"	457 mm & 305 mm
DK-100	Large aluminium protractor	48" & 36"	1219 mm & 914 mm

FRAMING SQUARE

The small stainless steel framing square measures angles, squareness, and finds pipe's centerline.

When used with a level, the square measures drops in inches per foot to determine slope. The square is marked in ⅛" increments.



⅛" increments (front and back)

PART NO D256



PART NO	DESCRIPTION	DIMENSIONS	
D256	Small Stainless Steel Framing Square	8" x 12" x ⅜" thick	203 x 305 x 1.6 mm thick

FLANGE SQUARES

Designed for the precise adjustment of flanges in tube/pipe construction.



PART NO TFSQ400



PART NO	DESCRIPTION	SIZE	
TFSQ300	Flange square 300 x 300 mm / 30 x 5 mm cross section	12" x 12"	300 mm x 300 mm
TFSQ400	Flange square 400 x 400 mm / 30 x 5 mm cross section	16" x 16"	400 mm x 400 mm
TFSQ500	Flange square 500 x 500 mm / 30 x 5 mm cross section	20" x 20"	500 mm x 500 mm



SPECIALIZED FABRICATION EQUIPMENT GROUP

Global Locations:



UNITED STATES HEAD OFFICE - HOUSTON

SPECIALIZED FABRICATION EQUIPMENT GROUP

4433 South Drive,
Houston,
Texas 77053, USA

Tel: +1 713 747 8502

E-mail: sales@sfe-brands.com

INTERNATIONAL HEAD OFFICE - FRANCE

SPECIALIZED FABRICATION EQUIPMENT GROUP

330B Route de Portes Les Valence,
ZI les Bosses,
26800 Etoile-sur-Rhône, France

Tel: + 33 (0) 475 575 070

E-mail: sales-int@sfe-brands.com

SFE UNITED KINGDOM

SPECIALIZED FABRICATION EQUIPMENT GROUP

Unit 15 & 16 Grendon Industrial Estate,
Grendon Underwood, Aylesbury,
Buckinghamshire, HP18 0QX England

Tel: +44 (0)1869 324 144

E-mail: sales-uk@sfe-brands.com

SFE GERMANY

SPECIALIZED FABRICATION EQUIPMENT GROUP

Ostmarkstrasse 15,
76437 Rastatt,
Germany

Tel: +49 (0)7222 9355100

E-mail: sales-germany@sfe-brands.com

SFE KINGDOM OF SAUDI ARABIA

SPECIALIZED FABRICATION EQUIPMENT GROUP

Warehouse No: EM16-10, Air Base Determinant,
Industrial supply scheme, Ash Shulah, Dammam
34264, Saudi Arabia

Tel: + 966 50 515 8196

E-mail: sales-ksa@sfe-brands.com

SFE MIDDLE EAST

SPECIALIZED FABRICATION EQUIPMENT GROUP

Shams Freezone
Sharjah

United Arab Emirates

Tel: +971 (0)50 217 1376

E-mail: sales-me@sfe-brands.com

SFE INDIA

SPECIALIZED FABRICATION EQUIPMENT GROUP

Plot No. PAP 3, D 3 Block,
Chinchwad, Pune 411 019

Mob: +91 90 1102 4332

Mob: +91 95 5258 4361

E-mail: sales-india@sfe-brands.com

SFE LATIN AMERICA

SPECIALIZED FABRICATION EQUIPMENT GROUP

4433 South Drive,
Houston,
Texas 77053, USA

Tel: +1 713 747 8502

E-mail: sales-latam@sfe-brands.com

SFE SOUTH KOREA

SPECIALIZED FABRICATION EQUIPMENT GROUP

102 - 1301 Bucheon Technopark III
421 - 742 Gyeonggi-do-seoul, Taehan-min'guk
South Korea

Tel: +82 32 624 2870

E-mail: sales-asia@sfe-brands.com

SFE VIETNAM

SPECIALIZED FABRICATION EQUIPMENT GROUP

P1.2.13 Sky-Linked Villa, Diamond Alnata,
Celadoncity, 89 Đường N1, P. Sơn Kỳ,
Q. Tân Phú, TpHCM.

Tel: +84 91 951 70 18

E-mail: sales-vietnam@sfe-brands.com

SFE CHINA

SPECIALIZED FABRICATION EQUIPMENT GROUP

1208, 12F, #D 7001 Zhongchun RD
Minhang District
Shanghai, China

Tel: +86 215 429 1891

E-mail: sales-china@sfe-brands.com

Copyright © 2023 Specialized Fabrication Equipment Group, All rights reserved.

OUR BRANDS

